

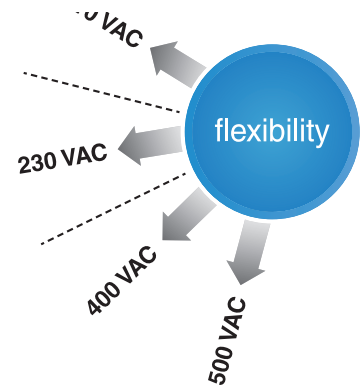

FLEX Power Single Phase 24V DC Power Supplies

More flexibility in input voltage

The FLEX line of power supplies are suitable to a wide range of input voltage. With a single type it is therefore possible to meet the requirements of more applications and consequently improve design activity and stock management.



More Power: *Power Boost*

As an example, PSA-18024 is a 24Vdc power supply that features a continuous duty current of 7.5A at 110°C and 5A at 60°C and a Power Boost of 150%, equivalent to 7.5A, for at least 3 min. This feature allows the use of a smaller size unit to power demanding loads such as motors, solenoid valves, lamps and other loads with transient overload behavior which would otherwise require an oversize power supply.

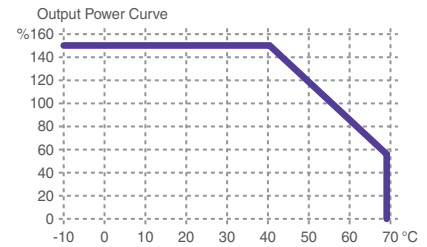

More flexibility in input voltage

As an example, PSA-18024 can be the right solution for two design cases in very different temperature conditions:

- 1) 7.5A, 24Vdc in continuous duty at 40°C.
- 2) 5A, 24Vdc in continuous duty at 60°C +Power Boost 7,5A for at least 3 min.

Power Good relay for monitoring the output voltage level

Output voltage is continuously monitored. The units 24 VDC output are equipped with Power Good relay. The NO contact triggers any time the output voltage level goes below 20Vdc (24 Vdc output). This feature is particularly useful in redundant applications.

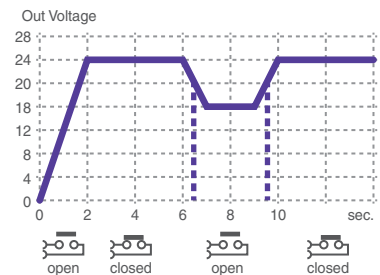

Applications in compliance with EN 60204-1 standard

The FLEX Power units comply with the requirement of EN60204-1 standard that an overload of 50% over the nominal current be withstand by the power supply for at least 1 hour to allow the tripping of magneto-thermic switches on the output. These features allows the implementation of "Control of commands and Emergency stops" by means of industrial PCs, PLC, remote I/O, etc. required by the standard.

FLEX Power Single Phase 24V DC Power Supplies

Hiccup Mode Automatic Restart

This is the default factory setting of all FLEX Power units. In case of shortcircuit or overloading, the output current is interrupted. The device tries again to re-establish output voltage and normal condition about every 2 second till the problem is cleared.

Manual Reset Mode Restart by Operator

In case of short-circuit or overload, the output current is interrupted. In order to restart the output it is necessary to switch-off the input circuit for about 1 minute. This protection mode is particularly suggested in applications where safety procedures require that reset be carried out only by an authorized person.

Continuous Output mode

In case of short-circuit or overload, the output current is kept at high values with near zero voltage. In case of short circuit the current can reach up to 3 times the rated current at 60°C. This protection mode is used to meet the requirements of demanding loads such as motors, solenoid valves, lamps, PLC with highly capacitive input circuits and other loads with marked transient overload behavior.

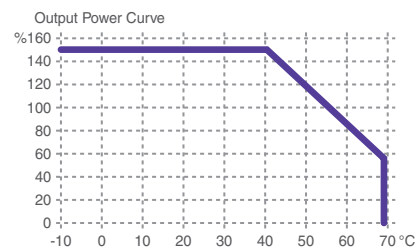
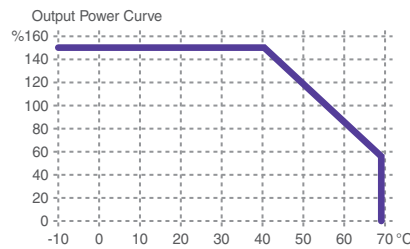
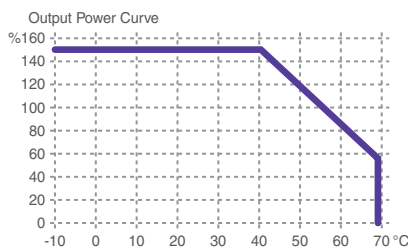

Jumper settings



HICUP
MODE



MANUAL
RESET



CONTINUOUS
OUT MODE

Output circuits protected by magneto-thermic circuit breakers

Standard output circuit breakers can be triggered quickly and reliably with FLEX technology, which allows three times the nominal current at 60°C. Defective current paths are selectively disconnected, the defect is limited and the important parts of the system remain in operation. This together with the 50% overload capacity in compliance with EN60204-1 allows to safely manage any overload and short circuit condition.

Reduced dimensions and snap-on DIN rail bracket

The higher performances obtained with the FLEX Power line, allow almost half dimensions as conventional technology and higher performances. An example is the PSA-12024 (120V) with maximum current is 12A. In permanent duty at 40°C it can deliver 5A at 24Vdc. All FLEX units feature the new DIN rail mounting bracket, easy to use and safe against heavy loading and vibrations.

Easy Parallel connection

With FLEX technology it is easy to double capacity. The units PSA-360, PSB-360, PSA-600 and PSB-600 can be easily connected in parallel without needing high precision instruments. Follow instructions supplied with each unit.

FLEX Power Single Phase 24V DC Power Supplies

Specifications



Features:

- Multiple overload/ short circuit protection modes
- Efficiency above 91%
- Small size
- DIN rail mountable
- Cooling by free air convection
- UL508 (industrial control equipment) approved
- EN60950-1
- Built-in DC OK relay contact
- 3 year warranty



120W DIN Rail Power Supply

Cat. No.	Phases	Output V DC A	Tol. %	Ripple & Noise	Efficiency	NOTES
PSA-12024	1	24V DC 5A	±3%	≤80 mVp-p	≥91%	



180W DIN Rail Power Supply

Cat. No.	Phases	Output V DC A	Tol. %	Ripple & Noise	Efficiency	NOTES
PSA-18024	1	24V DC 7.5A	±3%	≤80 mVp-p	≥91%	

12V DC and 48V DC output on request.



360W DIN Rail Power Supply

Cat. No.	Phases	Output V DC A	Tol. %	Ripple & Noise	Efficiency	NOTES
PSA-36024	1	24V DC 14A	±3%	≤80 mVp-p	≥91%	

12V DC and 48V DC output on request.



600W DIN Rail Power Supply

Cat. No.	Phases	Output V DC A	Tol. %	Ripple & Noise	Efficiency	NOTES
PSA-60024	1	24V DC 25A	±3%	≤80 mVp-p	≥92%	

48V DC output on request.

**Other output voltages on request.

SPECIFICATIONS

PSA-12024 Series

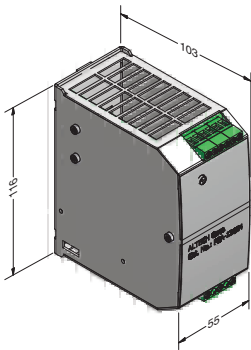

Terminal Pin. No Assignment (TB1)		Terminal Pin. No Assignment (TB2)	
Pin No.	Assignment PSA-12024 (1 phase)	Pin No.	Assignment PSA-12024 (1 phase)
1	N/AC	1/2	DC OUTPUT -V
2	L/AC	3/4	DC OUTPUT +V
3	FG ⊕	5/6	Relay Contact

Nominal Input Data: 115VAC/1.8A - 230VAC/0.9A (selectable by switch)

Connection: screw terminal blocks for wires 0.2-2.5mm² / AWG 24-14

Size (WxHxD): 55x116x103 mm (2.17x4.57x4.06 inches)

Packaging: 1/box; 0.5kg (1.1 lbs)

PSA-18024 Series

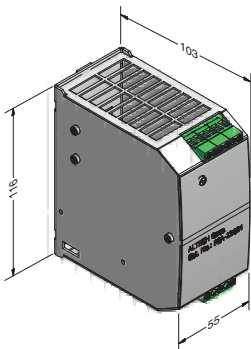

Terminal Pin. No Assignment (TB1)		Terminal Pin. No Assignment (TB2)	
Pin No.	Assignment PSA-18024 (1 phase)	Pin No.	Assignment PSA-18024 (1 phase)
1	N/AC	1/2	DC OUTPUT -V
2	L/AC	3/4	DC OUTPUT +V
3	FG ⊕	5/6	Relay Contact

Nominal Input Data: 115VAC/2.8A - 230VAC/1.3A (selectable by switch)

Connection: screw terminal blocks for wires 0.2-2.5mm² / AWG 24-14

Size (WxHxD): 55x116x103 mm (2.17x4.57x4.06 inches)

Packaging: 1/box; 0.6kg (1.32 lbs)

PSA-36024 Series

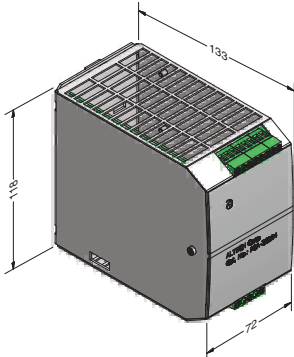

Terminal Pin. No Assignment (TB1)		Terminal Pin. No Assignment (TB2)	
Pin No.	Assignment PSA-36024 (1 phase)	Pin No.	Assignment PSA-36024 (1 phase)
1	N/AC	1/2/3	DC OUTPUT -V
2	L/AC	4/5/6	DC OUTPUT +V
3	FG ⊕	7/8	Relay Contact

Nominal Input Data: 115VAC/3.3A - 230VAC/2.2A (selectable by switch)

Connection: screw terminal blocks for wires 0.2-2.5mm² / AWG 24-14

Size (WxHxD): 72x118x133 mm (2.83x4.49x5.24 inches)

Packaging: 1/box; 0.72kg (1.59 lbs)

PSA-60024 Series

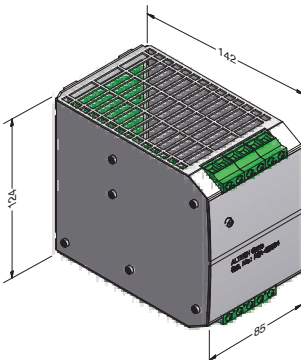

Terminal Pin. No Assignment (TB1)		Terminal Pin. No Assignment (TB2)	
Pin No.	Assignment PSA-60024 (1 phase)	Pin No.	Assignment PSA-60024 (1 phase)
1	N/AC	1/2	DC OUTPUT -V
2	L/AC	3/4	DC OUTPUT +V
3	Jumper 115V AC	5/6	Relay Contact
4	Jumper 115V AC		
5	FG ⊕		

Nominal Input Data: 115VAC/8.0A - 230VAC/4.2A (selectable by switch)

Connection: screw terminal blocks for wires up to 4mm² / 11AWG (solid), 6mm² / 10AWG (stranded)

Size (WxHxD): 85x120x142 mm (3.35x4.72x5.59 inches)

Packaging: 1/box; 1.0kg (2.2 lbs)



PSA-120 Series (1 Phase)

Specifications



Features:

- Multiple overload/ short circuit protection modes
- Efficiency above 91%
- Small size
- DIN rail mountable
- Cooling by free air convection
- UL 508 (industrial control equipment) approved
- EN60950-1
- Built-in DC OK relay circuit
- 3 year warranty

OUTPUT

Cat. No. PSA-12024

DC VOLTAGE	24 V
RATED CURRENT	5A
CURRENT RANGE	0-5A
RATED POWER	120 W
RIPPLE & NOISE (max)	100 mVp-p Ripple & noise are measured at 20MHz of bandwidth by using a 12" twisted pair-wire terminated with a 0.1µF & 47µF parallel capacitor.
VOLTAGE ADJ. RANGE	22 V ~ 27 V
VOLTAGE TOLERANCE	-0.3% Tolerance: includes set up tolerance, line regulation and load regulation.
START UP WITH STRONG LOAD	≤ 50,000 µF
SHORT CIRCUIT CURRENT I _{cc}	12A Max 2 sec.: Hiccup mode Permanent: Continuous mode
DISSIPATION POWER LOAD max	11 W
LINE REGULATION	± 0.5%
LOAD REGULATION	± 1%
SETUP, RISE TIME	1 sec. (max) Length of set up time is measured at cold first start. Turning ON/OFF the power supply may lead to increase of the set up time.
HOLD UP TIME (Typ.)	20 msec

INPUT

VOLTAGE RANGE	90 ~ 135V AC / 180 ~ 264V AC switch select
FREQUENCY RANGE	47 ~ 63 Hz
EFFICIENCY (Typ.)	>91 %
AC CURRENT (115 - 230V)	1.8 - 0.9V AC
INRUSH CURRENT (Typ.)	< 11 A ≤ 5 msec
INTERNAL FUSE	4A (T)
EXTERNAL FUSE (recommended)	10 A (MCB curve B)
LEAKAGE CURRENT	< 1.5 mA @ 230 V AC

PROTECTION

OVERLOAD	In (60°C) x 1.5 ³ ≥ 3 min. Current max. Overload @ 4VDC (permanent) I _{max} =In (60°C) x (1.8 - 2.2)
OVER VOLTAGE	30 ~ 35 VDC
OVER TEMPERATURE	Shuts down output and automatically restarts when the temperature inside goes down
SHORT CIRCUIT PROTECTION	1 Hiccup Mode / 2 Fold Back / 3 Restart After Main - Selectable

ENVIRONMENT

WORKING TEMP.	-25 up to +70 °C
HUMIDITY	95 % at 25°C, no condensation
STORAGE TEMP.	-40 up to +85 °C
TEMP. COEFFICIENT	± 0.03% / C° (0 ~ 60 °C)
MOUNTING	In according to IEC60068-2-6

SAFETY & EMC

SAFETY STANDARDS	UL508 Listed, IEC/EN 60950, EN 50178, IEC/EN 60950, EN60950-1, PELV EN 60204-1
WITHSTAND VOLTAGE	I/P-O/P: 3k VAC I/P-FG: 1.6k VAC O/P-FG: 500 VAC
PROTECTION CLASS	IP 20 (EN/IEC 60529)
ISOLATION RESISTANCE	100 MΩ (min) @ 500 VDC
EMI CONDUCTION & RADIATION	EN61000-6-4
HARMONIC CURRENT	EN61000-3-2
EMS IMMUNITY	EN 61000-4-2, EN 61000-4-3, EN 61000-4-4, EN 61000-4-5, EN 61000-4-6, EN61000-6-2, The power supply is considered a component which will be installed into a final equipment. The final equipment must be re-confirmed that it still meets EMC directives.

OTHERS

MTBF IEC 61709	> 500.000 h
DC OK AKTIV SIGNAL (max.)	20 ~ 30 VDC
POLLUTION DEGREE	2
CONNECTION TERMINAL BLOCK	2.5 mm Screw terminal (24 ~ 14 AWG)
DIMENSION	55x110x105 mm (2.16x4.33x4.13 in)
PACKING	0.50 kg (1.1 lbs) each

All parameters NOT specially mentioned are measured at 230V AC input, rated load and 25°C of ambient temperature.

Mechanical Specification

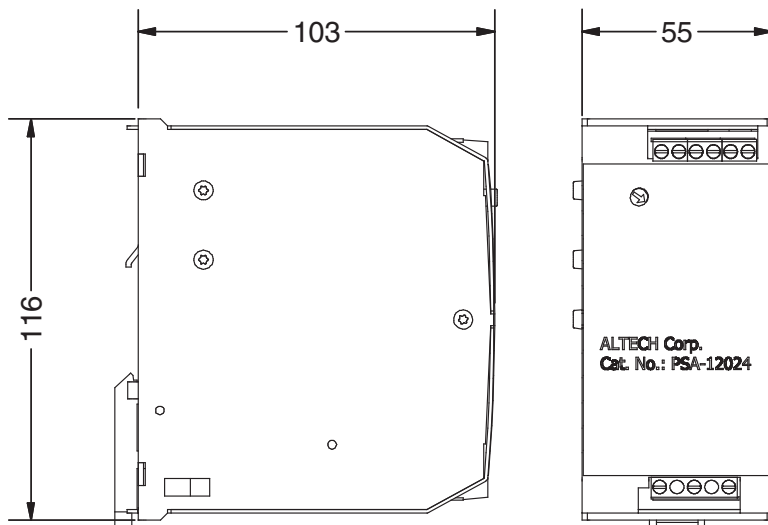

TB1 Terminal Pin. No Assignment

Pin No.	Assignment (1 phase)
1	N / AC
2	L / AC
2	FG ⊕

TB2 Terminal Pin. No Assignment

Pin No.	Assignment
1,2	DC output -V
3,4	DC output +V
5,6	DC OK relay contacts

DC OK Relay Contact

Outputs are used for preventive function monitoring of the power supply. An electrically isolated signal contact is available. The signal contact closes when the output power is OK and opens when the output voltage falls below 20Vdc $\pm 5\%$.

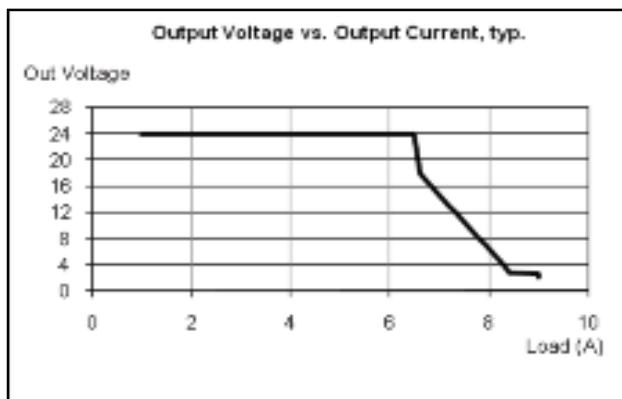

Output Derating Curve

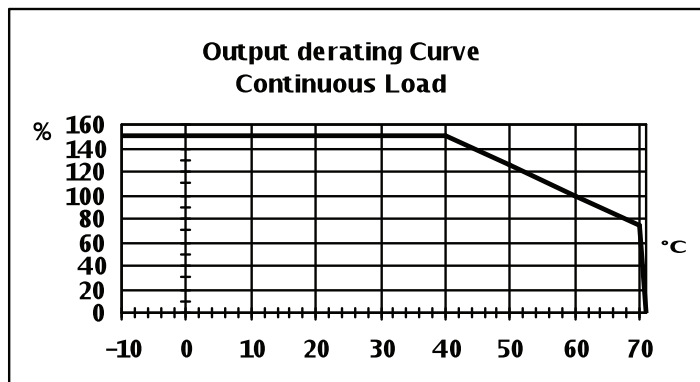



PSA-180 Series (1 Phase)

Specifications

Features:

- Multiple overload/ short circuit protection modes
- Efficiency above 91%
- Small size
- DIN rail mountable
- Cooling by free air convection
- UL508 (industrial control equipment) approved
- EN60950-1
- Built-in DC OK relay contact
- 3 year warranty



OUTPUT

Cat. No.	PSA-18024
DC VOLTAGE	24 V
RATED CURRENT	7.5 A
CURRENT RANGE	0-7.5A
RATED POWER	180 W
RIPPLE & NOISE (max)	100 mVp-p
VOLTAGE ADJ. RANGE (DC)	10 V ~ 14 V
VOLTAGE TOLERANCE	-0.03
START UP WITH STRONG LOAD	≤ 50,000 μF
SHORT CIRCUIT CURRENT I _{cc}	16 A Max 2 sec.: Hiccup mode Permanent: Continuous mode
DISSIPATION POWER LOAD mas	17 W
LINE REGULATION	± 0.5%
LOAD REGULATION	± 1%
SETUP, RISE TIME	1 sec. (max) Length of set up time is measured at cold first start. Turning ON/OFF the power supply may lead to increase of the set up time.
HOLD UP TIME (Typ.)	Typ. 20 msec

INPUT

VOLTAGE RANGE	90 ~ 135V AC / 180 ~ 264V AC switch select
FREQUENCY RANGE	47 ~ 63 Hz +-6%
EFFICIENCY (Typ.)	>91 %
AC CURRENT (115 – 230 Vac.)	2.8 ~ 1.3 A
INRUSH CURRENT (Typ.)	< 11 A < 5 msec
INTERNAL FUSE	4A (T)
EXTERNAL FUSE (recommended)	10 A (MCB curve B)
LEAKAGE CURRENT	< 1.5 mA @ 230 Vac

PROTECTION

OVERLOAD	In (60°C) x 1.5 ³ (3 min.) Current max. Overload @ 4Vdc (permanent) I _{max} =In (60°C) x (1.8 - 2.2)
OVER VOLTAGE	30 ~ 35 Vdc
OVER TEMPERATURE	Yes. Shuts down output and automatically restarts when the temperature inside goes down
SHORT CIRCUIT PROTECTION	1 Hiccup Mode / 2 Fold Back / 3 Restart After Main - Selectable

ENVIRONMENT

DC OK AKTIV SIGNAL (max.)	20 ~ 30 Vdc
WORKING TEMP.	-25 up to +70 °C
HUMIDITY	95 % at 25°C, no condensation
STORAGE TEMP	-40 up to +85 °C
TEMP. COEFFICIENT	± 0.03% / C° (0 ~ 60 °C)
MOUNTING	In according to IEC60068-2-6

SAFETY & EMC

SAFETY STANDARDS	UL508 Listed IEC/EN 60950, EN 50178, IEC/EN 60950, EN60950-1, PELV EN 60204-1
WITHSTAND VOLTAGE	I/P-O/P: 3k VAC I/P-FG: 1.6k VAC O/P-FG: 500 VAC
PROTECTION CLASS	IP 20 (EN/IEC 60529)
ISOLATION RESISTANCE	100 MΩ (min) @ 500 Vdc
EMI CONDUCTION & RADIATION	EN61000-6-4
HARMONIC CURRENT	EN61000-3-2
EMS IMMUNITY	EN 61000-4-2, EN 61000-4-3, EN 61000-4-4, EN 61000-4-5, EN 61000-4-6, EN61000-6-2, EN61000-6-4, The power supply is considered a component which will be installed into a final equipment. The final equipment must be re-confirmed that it still meets EMC directives.

OTHERS

MTBF IEC 61709	> 500.000 h
POLLUTION DEGREE	2
CONNECTION TERMINAL BLOCK	2.5 mm Screw terminal (24 ~ 14 AWG)
DIMENSION	55x110x105 mm (2.16x4.33x4.13 in)
PACKING	0.60 kg (1.3 lbs) each
NOTE	All parameters NOT specially mentioned are measured at 230V AC input, rated load and 25°C of ambient temperature.

Mechanical Specification

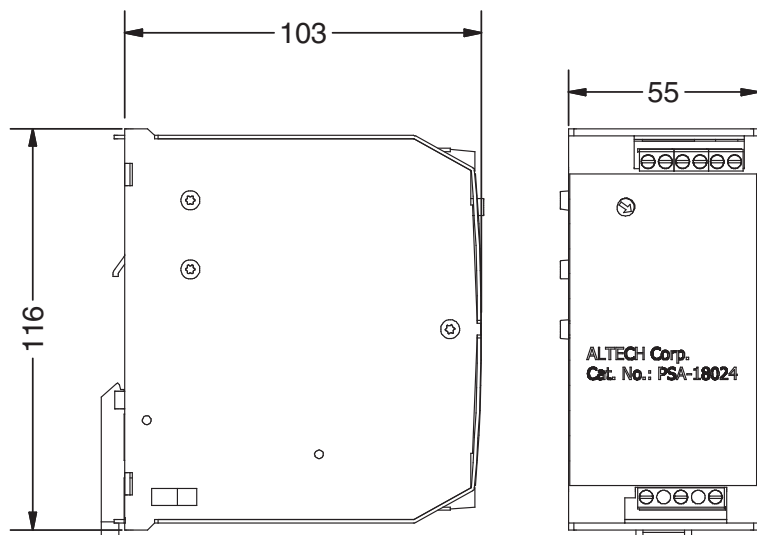

TB1 Terminal Pin. No Assignment

Pin No.	Assignment (1 phase)
1	N / AC
2	L / AC
3	FG ⊕

TB1 Terminal Pin. No Assignment

Pin No.	Assignment
1,2	DC output -V
3,4	DC output +V
5,6	DC OK relay contacts

DC OK Relay Contact

Outputs are used for preventive function monitoring of the power supply. An electrically isolated signal contact is available. The signal contact closes when the output power is OK and opens when the output voltage falls below 20Vdc \pm 5%.

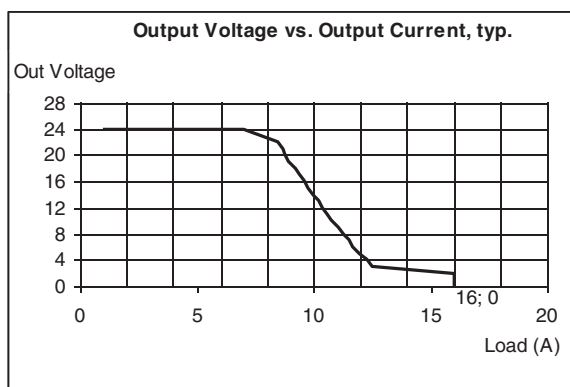

Output Derating Curve

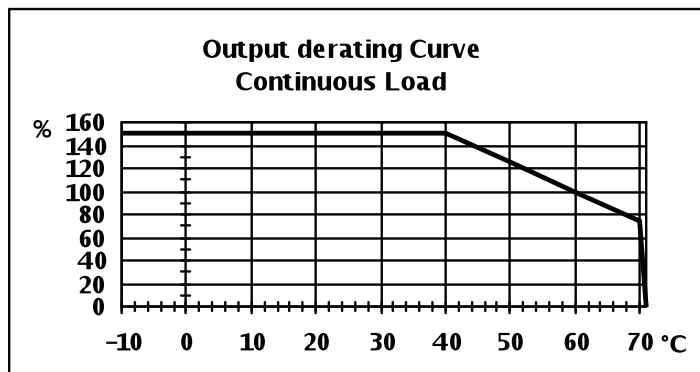



PSA-360 Series (1 Phase)

Specifications

Features:

- Multiple overload/ short circuit protection modes
- Efficiency above 91%
- **Easy parallel connection for more power**
- Small size
- DIN rail mountable
- Cooling by free air convection
- UL508 (industrial control equipment) approved
- EN60950-1
- Built-in DC OK relay contact
- 3 year warranty



OUTPUT

Cat. No. PSA-36024

DC VOLTAGE	24 V
RATED CURRENT	14 A
CURRENT RANGE	0 ~ 14 A
RATED POWER	336 W
RIPPLE & NOISE (max)	80 mVp-p
VOLTAGE ADJ. RANGE (DC)	Ripple & noise are measured at 20MHz of bandwidth by using a 12" twisted pair-wire terminated with a 0.1µF & 47µF parallel capacitor. 22 ~ 27 V
VOLTAGE TOLERANCE	-0.03
START UP WITH STRONG LOAD	Tolerance: includes set up tolerance, line regulation and load regulation. ≤ 50,000 µF
SHORT CIRCUIT CURRENT I _{cc}	30 A Max 2 sec.: Hiccup mode Permanent: Continuous mode
DISSIPATION POWER LOAD <i>mas</i>	28 W
LINE REGULATION	± 0.5%
LOAD REGULATION	± 1%
SETUP, RISE TIME	1 sec. (max) Length of set up time is measured at cold first start. Turning ON/OFF the power supply may lead to increase of the set up time.
HOLD UP TIME (Typ.)	Typ. 20 msec
VOLTAGE RANGE	90 ~ 135V AC / 180 ~ 264V AC switch select

INPUT

FREQUENCY RANGE	47 ~ 63 Hz
EFFICIENCY (Typ.)	>91 %
AC CURRENT (115 – 230 Vac.)	3.3 ~ 2.2 A
INRUSH CURRENT (Typ.)	< 16 A < 5 msec
INTERNAL FUSE	6.3 A (T)
EXTERNAL FUSE (recommended)	16 A (MCB curve B)
LEAKAGE CURRENT	< 1.5 mA @ 230 Vac

PROTECTION

OVERLOAD	In (60°C) x 1.5 ³ (3 min.) Current max. Overload @ 4Vdc (permanent) I _{max} =I _n (60°C) x (1.8 - 2.2)
OVER VOLTAGE	14 ~ 17 Vdc 30 ~ 35 Vdc 50 ~ 55 Vdc
OVER TEMPERATURE	Yes. Shuts down output and automatically restarts when the temperature inside goes down
SHORT CIRCUIT PROTECTION	1 Hiccup Mode / 2 Fold Back / 3 Restart After Main - Selectable

ENVIRONMENT

DC OK AKTIV SIGNAL (max.)	20 ~ 30 Vdc
WORKING TEMP.	-25 up to +70 °C (>60°derating 2.5% °C)
HUMIDITY	95 % at 25°C, no condensation
STORAGE TEMP	-40 up to +85 °C
TEMP. COEFFICIENT	± 0.03% / C° (0 ~ 60 °C)
MOUNTING	In according to IEC60068-2-6

SAFETY & EMC

SAFETY STANDARDS	UL508 Listed IEC/EN 60950, EN 50178, IEC/EN 60950, EN60950-1, PELV EN 60204-1
WITHSTAND VOLTAGE	I/P-O/P: 3k VAC I/P-FG: 1.6k VAC O/P-FG: 500 VAC
PROTECTION CLASS	IP 20 (EN/IEC 60529)
ISOLATION RESISTANCE	100 MΩ (min) @ 500 Vdc
EMI CONDUCTION & RADIATION	EN61000-6-4
HARMONIC CURRENT	
EMS IMMUNITY	EN 61000-4-2, EN 61000-4-3, EN 61000-4-4, EN 61000-4-5, EN 61000-4-6, EN61000-6-2, EN61000-6-4, The power supply is considered a component which will be installed into a final equipment. The final equipment must be re-confirmed that it still meets EMC directives.

OTHERS

MTBF IEC 61709	> 500.000 h
POLLUTION DEGREE	2
CONNECTION TERMINAL BLOCK	2.5 mm Screw terminal (24 ~ 14 AWG)
DIMENSION	72x115x135 mm (2.8x4.5x5.3 in)
PACKING	0.65 kg (1.4 lbs) each
NOTE	All parameters NOT specially mentioned are measured at 230V AC input, rated load and 25°C of ambient temperature.

Mechanical Specification

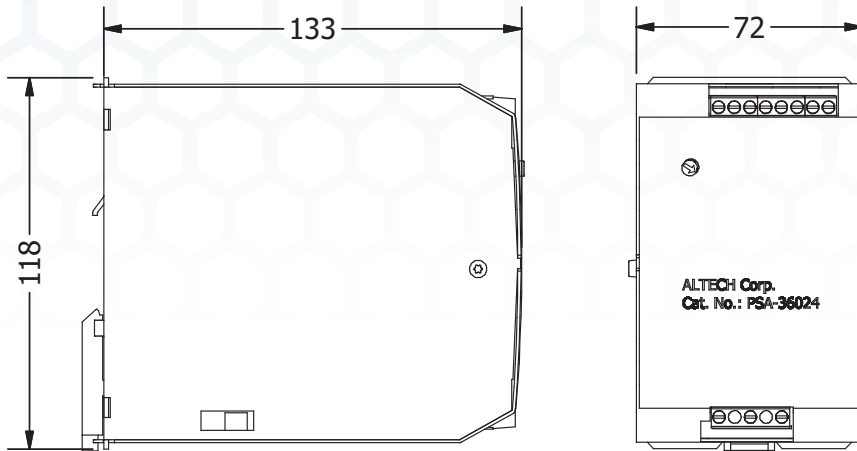

TB1 Terminal Pin. No Assignment

Pin No.	Assignment (1 phase)
1	N
2	L
	FG ⊕

TB1 Terminal Pin. No Assignment

Pin No.	Assignment
1,2,3	DC output -V
4,5,6	DC output +V
7,8	DC OK relay contacts

DC OK Relay Contact

Outputs are used for preventive function monitoring of the power supply. An electrically isolated signal contact is available. The signal contact closes when the output power is OK and opens when the output voltage falls below 20Vdc ±5%.

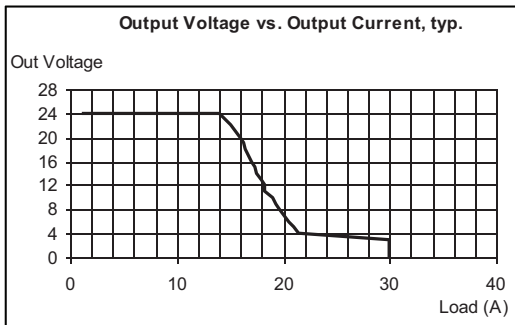

Output Derating Curve

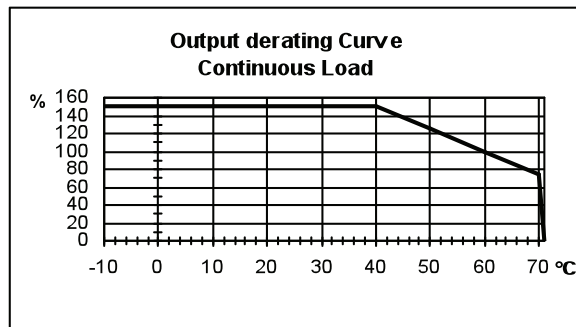

Parallel Connection

A parallel connection with the same model power supply can be set up to increase the output power. The output has to be adjusted approximately to the same value (± 20mV) while applying a 1-2 A load to all devices before connecting them in parallel. In PSA-360xx, for more power, the position of the Easy Parallel jumper needs to be changed to enable a parallel connection. In this mode up to 4 power supplies can be put together in parallel.

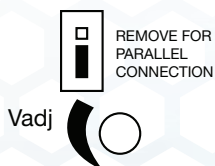
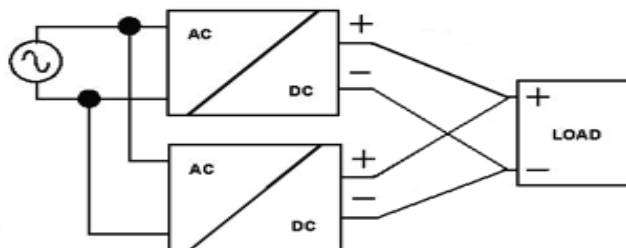

Easy Parallel connection
OFF (factory selection)

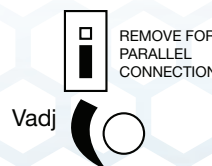

Easy Parallel
ON

Note: All dimensions are in millimeters, to convert to inches multiply by 0.03937.

PSC Class 2 Series
Compact Housing

PSA Flex Series
1 Phase

PSB Flex Series
2 & 3 Phase

PS-S Slim Series
Plastic Housing

PS Low Profile Series
Plastic Housing

PS Industrial Series
1, 2 & 3 Phase

PS C & W Series
1 and 2 Phase

CBI Type
DC UPS Systems

CB Type
Battery Chargers

Accessories

Appendix



PSA-600 Series (1 Phase)

Specifications



Features:

- Multiple overload/ short circuit protection modes
- Efficiency above 92%
- **Easy parallel connection for more power**
- Small size
- DIN rail mountable
- Cooling by free air convection
- UL508 (industrial control equipment) approved
- EN60950-1
- Built-in DC OK relay contact
- 3 year warranty

OUTPUT

Cat. No. PSA-60024

DC VOLTAGE	24 V
RATED CURRENT	25 A
CURRENT RANGE	0-25A
RATED POWER	600 W
RIPPLE & NOISE (max)	100 mVp-p
VOLTAGE ADJ. RANGE	22 V ~ 27 V
VOLTAGE TOLERANCE	-0.03
START UP WITH STRONG LOAD	≤ 50,000 μF
SHORT CIRCUIT CURRENT I _{cc}	60 A Max 2 sec.: Hiccup mode Permanent: Continuous mode
DISSIPATION POWER LOAD P _{max}	54 W
LINE REGULATION	± 0.5%
LOAD REGULATION	± 1%
SETUP, RISE TIME	1 sec. (max)
HOLD UP TIME (Typ.)	Length of set up time is measured at cold first start. Turning ON/OFF the power supply may lead to increase of the set up time. Typ. 20 msec

INPUT

VOLTAGE RANGE	90 ~ 135V AC / 180 ~ 264V AC switch select
FREQUENCY RANGE	47 ~ 63 Hz +-6%
EFFICIENCY (Typ.)	>91 %
AC CURRENT (115 – 230 Vac.)	8 ~ 4.2 A
INRUSH CURRENT (Typ.)	< 16 A < 5 msec
INTERNAL FUSE	10A (T)
EXTERNAL FUSE (recommended)	16 A (curve B)
LEAKAGE CURRENT	< 1.5 mA @ 230 Vac

PROTECTION

OVERLOAD	In (60°C) x 1.5 ³ (3 min.) Current max. Overload @ 4Vdc (permanent) I _{max} =In (60°C) x (1.8 - 2.2)
OVER VOLTAGE	30 ~ 35 Vdc
OVER TEMPERATURE	Yes. Shuts down output and automatically restarts when the temperature inside goes down
SHORT CIRCUIT PROTECTION	1 Hiccup Mode / 2 Fold Back / 3 Restart After Main - Selectable

ENVIRONMENT

DC OK AKTIV SIGNAL (max.)	20 ~ 30 Vdc
WORKING TEMP.	-25 up to +70 °C
HUMIDITY	95 % at 25°C, no condensation
STORAGE TEMP	-40 up to +85 °C
TEMP. COEFFICIENT	± 0.03% / °C (0 ~ 60 °C)
MOUNTING	In according to IEC60068-2-6

SAFETY & EMC

SAFETY STANDARDS	UL508 Listed IEC/EN 60950, EN 50178, IEC/EN 60950, EN60950-1, PELV EN 60204-1
WITHSTAND VOLTAGE	I/P-O/P: 3k VAC I/P-FG: 1.6k VAC O/P-FG: 500 VAC
PROTECTION CLASS	IP 20 (EN/IEC 60529)
ISOLATION RESISTANCE	100 MΩ (min) @ 500 Vdc
EMI CONDUCTION & RADIATION	EN61000-6-4
HARMONIC CURRENT	
EMS IMMUNITY	EN 61000-4-2, EN 61000-4-3, EN 61000-4-4, EN 61000-4-5, EN 61000-4-6, EN61000-6-2, EN61000-6-4, The power supply is considered a component which will be installed into a final equipment. The final equipment must be re-confirmed that it still meets EMC directives.

OTHERS

MTBF IEC 61709	> 500.000 h
POLLUTION DEGREE	2
CONNECTION TERMINAL BLOCK	4 mm Screw terminal (30 ~ 10 AWG)
DIMENSION	85x120x140 mm (3.34x4.72x5.51 in)
PACKING	0.75 kg (1.9 lbs) each
NOTE	All parameters NOT specially mentioned are measured at 230V AC input, rated load and 25°C of ambient temperature.

Mechanical Specification

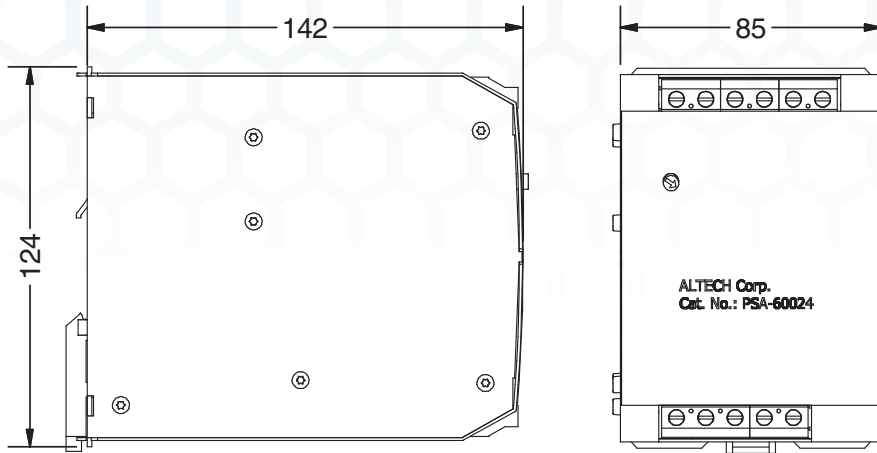

TB1 Terminal Pin. No Assignment

Pin No.	Assignment (1 phase)
1	N / AC
2	L / AC
3	Jumper 115V AC
4	Jumper 115V AC
5	FG⊕

TB2 Terminal Pin. No Assignment

Pin No.	Assignment
1,2	DC output -V
3,4	DC output +V
5,6	DC OK relay contacts

DC OK Relay Contact

Outputs are used for preventive function monitoring of the power supply. An electrically isolated signal contact is available. The signal contact closes when the output power is OK and opens when the output voltage falls below 20Vdc ±5%.

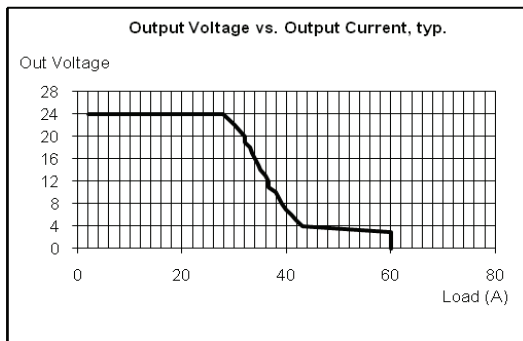

Output Derating Curve

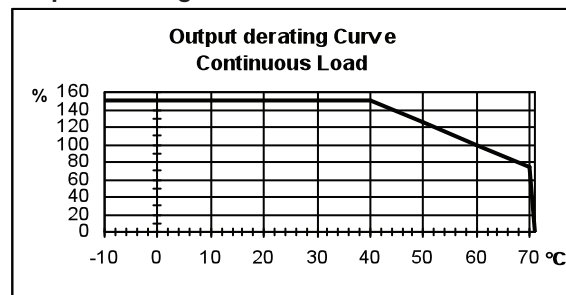

Parallel Connection

A parallel connection with the same model power supply can be set up to increase the output power. The output has to be adjusted approximately to the same value (± 20mV) while applying a 1-2 A load to all devices before connecting them in parallel. In PSA-600xx, for more power, the position of the Easy Parallel jumper needs to be changed to enable a parallel connection. In this mode up to 4 power supplies can be put together in parallel.

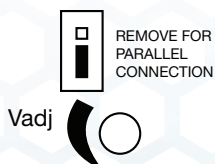
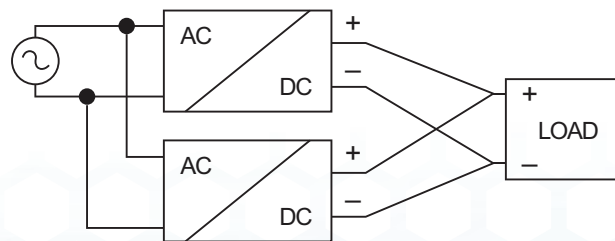

Easy Parallel connection
OFF (factory selection)

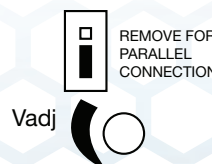

Easy Parallel
ON

Note: All dimensions are in millimeters, to convert to inches multiply by 0.03937.

PSC Class 2 Series
Compact Housing

PSA Flex Series
1 Phase

PSB Flex Series
2 & 3 Phase

PS-S Slim Series
Plastic Housing

PS Low Profile Series
Plastic Housing

PS Industrial Series
1, 2 & 3 Phase

PS C & W Series
1 and 2 Phase

CBI Type
DC UPS Systems

CB Type
Battery Chargers

Accessories

Appendix